

**Not Now**

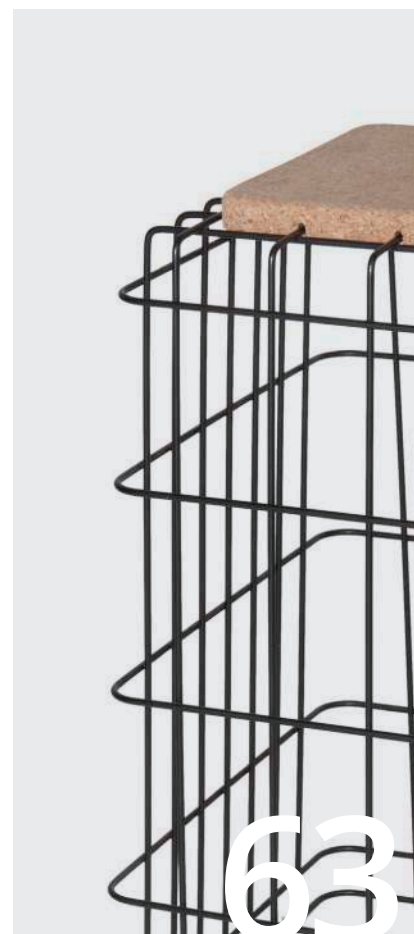

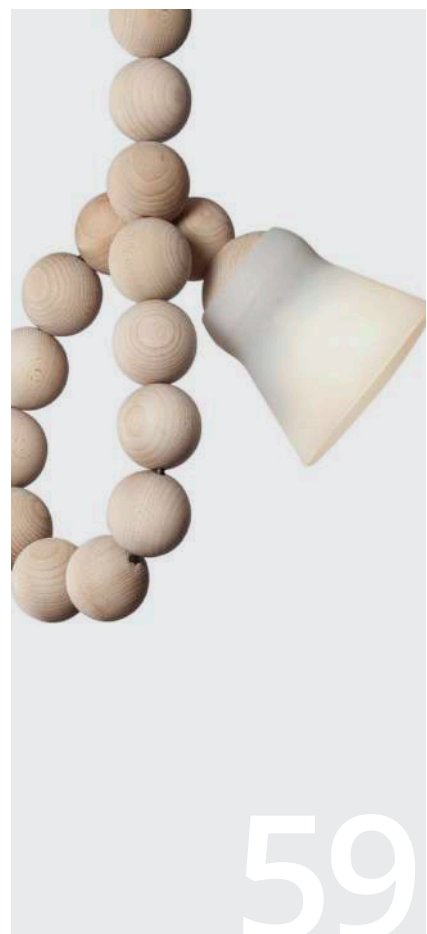

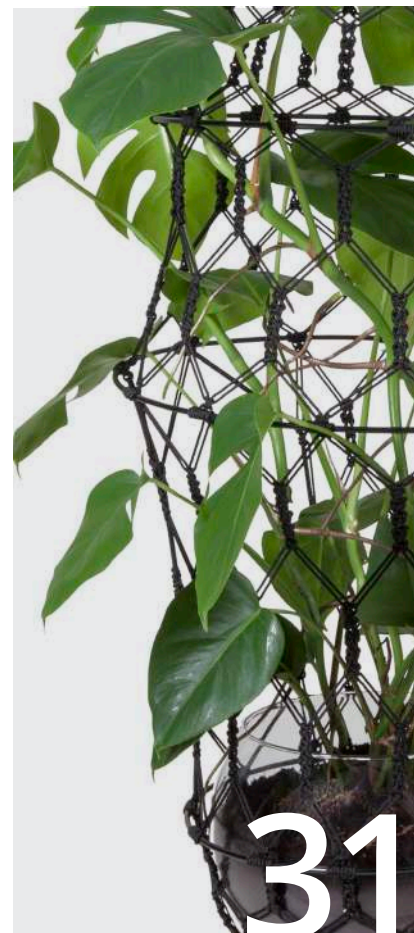
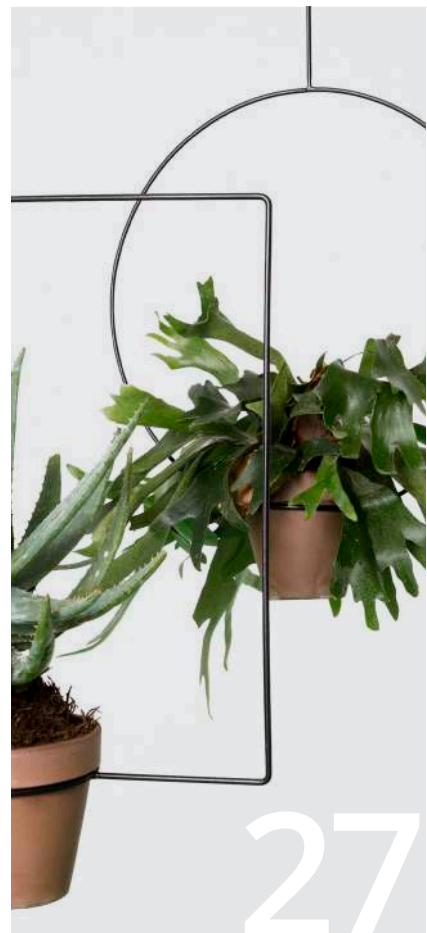

FRAN



The lights are handmade in Riga. Like plant hanger LUCILLE, FRAN is produced as part of a social project that gives young mothers the opportunity to work flexible hours.





FRAN is available in four bold block colors (beige, coral, green and black), that work on their own as in monochrome or contrasting combinations as well.

FRAN	
description:	pendant light
material:	raffia fringes
colours available :	coral, beige, green, black
including:	light bulb is not included
made in:	latvia
production:	100% hand made
availability:	in stock
years of development:	2018
design:	Ilot Ilov
website:	www.IlotIlov.com
pendant light:	XL
measurements:	650mm x 700mm
weight:	5,5 kg
pendant light:	L
measurements:	500mm x 450mm
weight:	3 kg
pendant light:	M
measurements:	450mm x 650mm
weight:	3 kg
pendant light:	S
measurements:	400mm x 350mm
weight:	1,5 kg
pendant light:	XS
measurements:	240mm x 300mm
weight:	1,5 kg

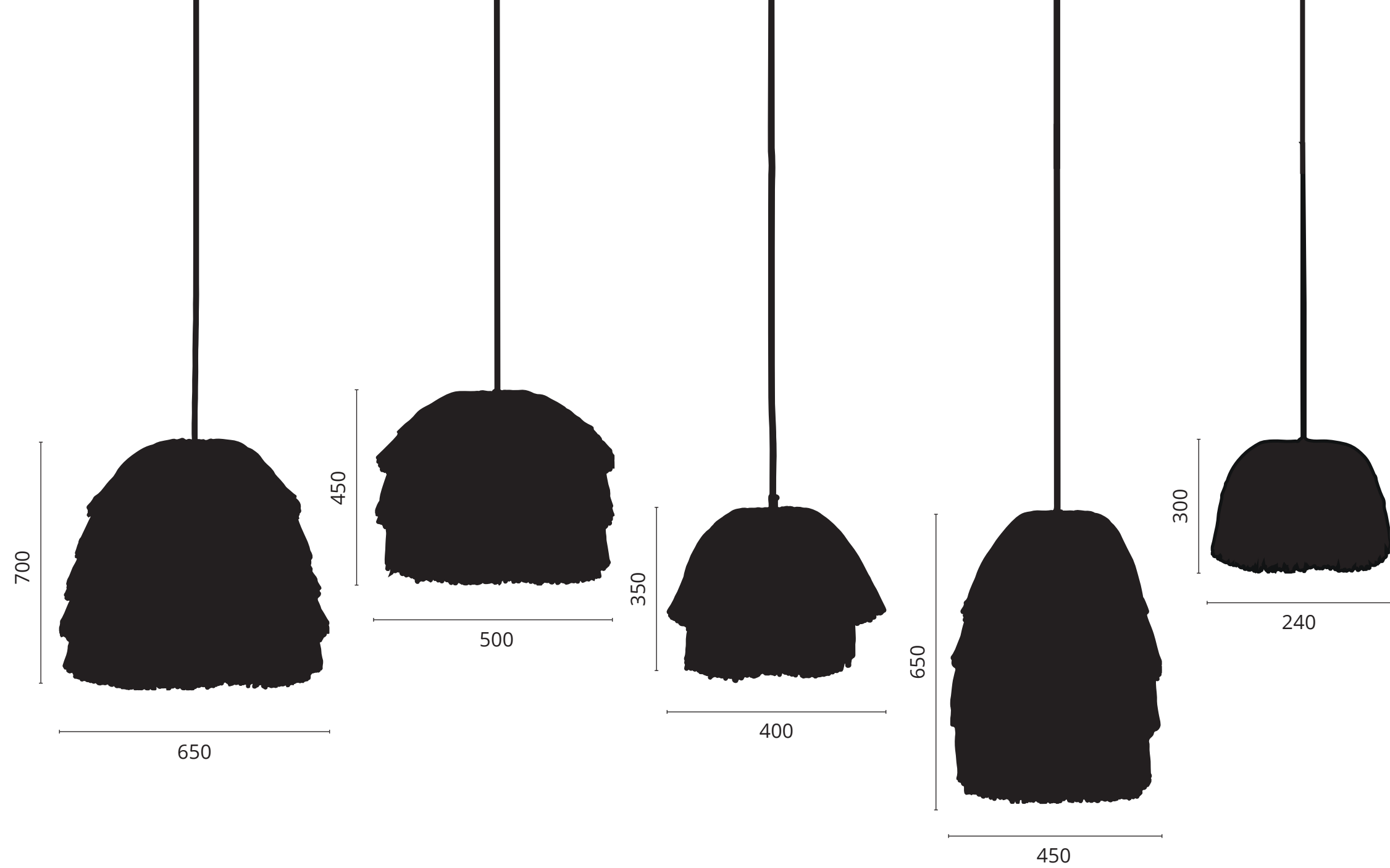





HOOK



HOOK is a cylindric round wood that adjusts itself and thus becomes a little helper at every corner. Whether it be a wall or a cabinet, each and everything can with the help of HOOK become a piece of furniture with hooks or a very special coat rack. The cylinder is wedged tight in a 90-degree angle and stable enough to carry some weight.





HOOK comes in natural beech wood or black lacquered.  
It comes in pairs, but can be individually applied and combined to create a very personal coat rack.

HOOK	
description:	hook for edges; set of two
material:	beech wood
including:	rawlplugs, screws
colours available :	black, natural
made in:	germany
production:	100% hand made
availability:	in stock
years of development:	2019
design:	llo t llov
website:	<a href="http://www.llotllov.com">www.llotllov.com</a>
hook:	corner hook
measurements:	50 mm x 180 mm
weight:	600 gram







**GUR**



In collaboration with the Portuguese rug label ›rug by GUR‹ we designed our supersize pillows created from their handmade multicoloured rugs. Because of their size, they double as a seat cushion as well as a rest.

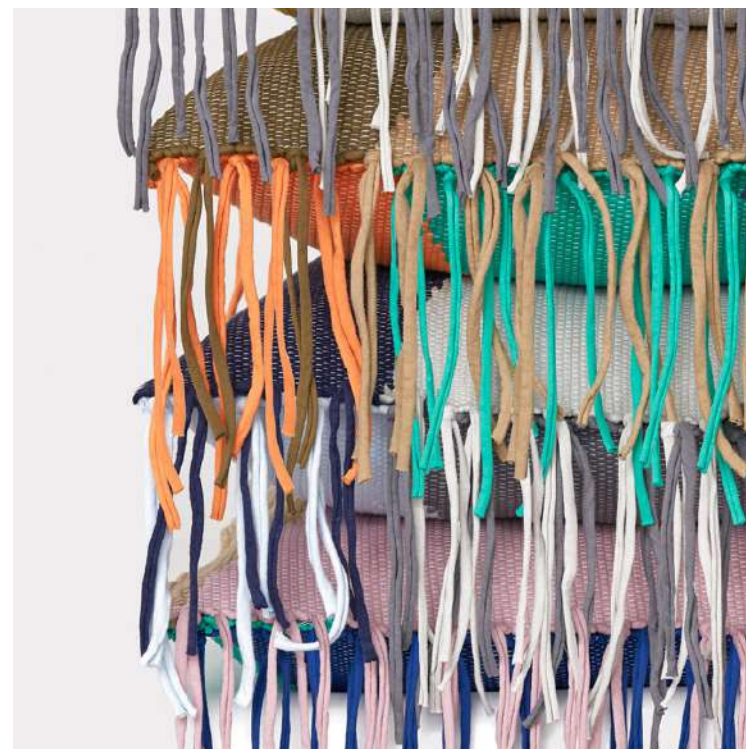





Front and back of the GUR pillow display contrasting colours that melt into the fringes to both sides.

GUR PILLOW	
description:	pillow case
material:	cotton
including:	pillow not included
colours available :	multicoloured
made in:	portugal
production:	100% hand made
availability:	in stock
years of development:	2019
design:	Ilot Ilov
website:	<a href="http://www.IlotIlov.com">www.IlotIlov.com</a>
pillow case:	GUR pillow
measurements:	800mm x 600mm
weight:	1,5 kg

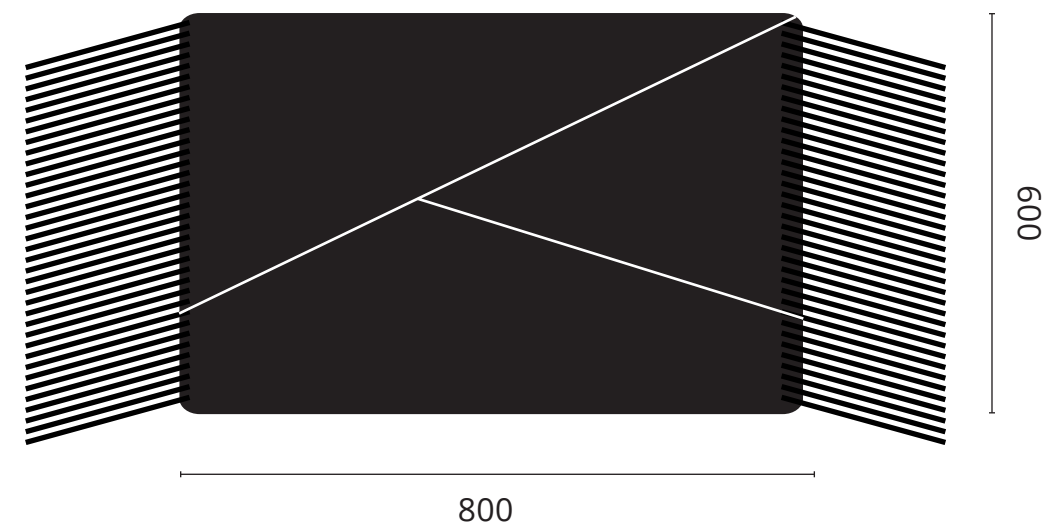



NMP





The bedside table NAP is made from powdered sheet steel. The material makes it appear delicate, however, it is solid and can carry a full load.



NAP	
description:	bedside table
material:	sheet steel
colour:	green, brown
including:	
made in:	germany
production:	100% hand made
availability:	on request
years of development:	2012
design:	Ilot Ilov
website:	<a href="http://www.ilotilov.com">www.ilotilov.com</a>
bedside table:	bedside table
measurements:	350mm x 370mm x 600mm
weight:	10 kg

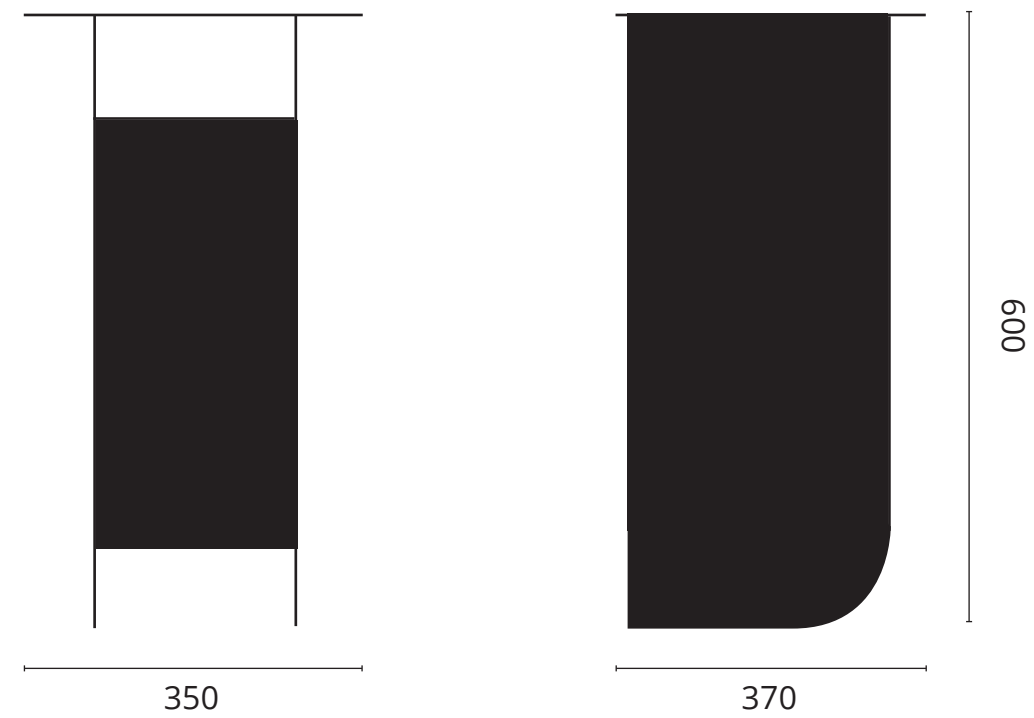







The MEDEIA trio is not only divers through its geometric cuts. Each vase has its purpose of bouquet of flowers. Since MEDEIA BOLD restrains the wild branches, MEDEIA SLIM loves to hold just one flower. MEDEIA MIDI is self-confident even without any flower bouquet and charming just though its clear geometric shape. Not every vase needs to carry flowers.





With their geometric and austere shapes, the three vases are a sculptural counterpart to the bouquet of flowers they hold. The MEDEIA SLIM hip keeps the posy together, while the stems have space and water. The Trio is made from powder-coated aluminum and dresses in black, white, blue, raw and pigeon.





MEDEIA	
description:	geometric vase
material:	aluminum
surface:	powder coated, raw
colours available :	white, black, blue, pigeon, raw
made in:	india
production:	100% hand made
availability:	in stock
years of development:	2016
design:	Ilot Ilov
website:	www.IlotIlov.com
vase:	bold
measurements:	250mm x 220mm
weight:	800g
vase:	midi
measurements:	160mm x 270mm
weight:	650g
vase:	slim
measurements:	50mm x 420mm
weight:	500g

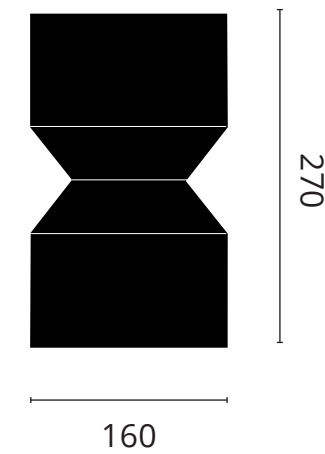
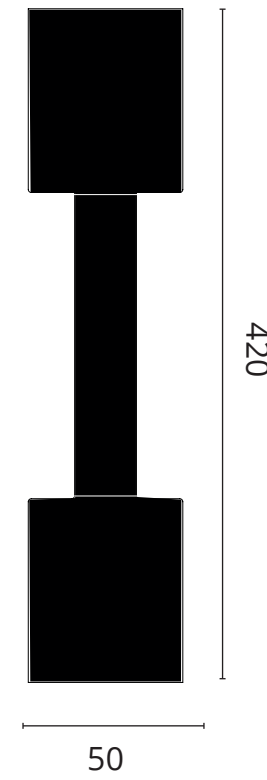
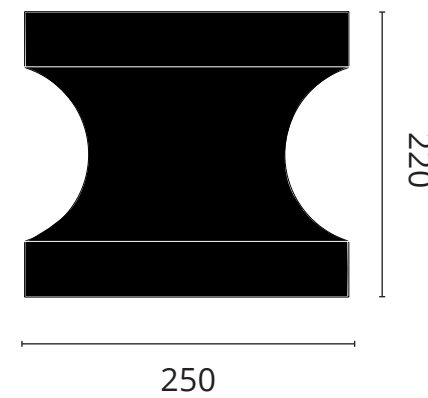







Like MEDEIA it was made in a metal spinning process out of aluminum, but this one is meant to be the new home for plants with roots. They come in four types, all can be filled from both sides, allowing for endless combinations from cactus as well as palm trees. Each plant pot is hand-turned and hand-brushed and is reminiscent of an untreated industrial piece. The slightly reflective metal surface creates a beautiful contrast to the fresh green leaves. The new planter edition is suitable for indoor, but also for outdoor use. For exterior use, the rubber plug should be removed to prevent rainwater from accumulating. As the surface is not lacquered, the material ages in a natural way, but is resistant to corrosion.







ADA	
description:	indoor and outdoor planter
material:	aluminum
surface:	powder coated, raw
colours available :	black, raw
made in:	india
production:	100% hand made
availability:	in stock
years of development:	2019
design:	llo t llov
website:	www.llo t llov.com
planter:	large
measurements:	520mm x 320mm
weight:	1,7kg
planter:	bold
measurements:	500mm x 350mm
weight:	1,5 kg
planter:	midi
measurements:	370mm x 230mm
weight:	1kg
planter:	small
measurements:	340mm x 210mm
weight:	1kg

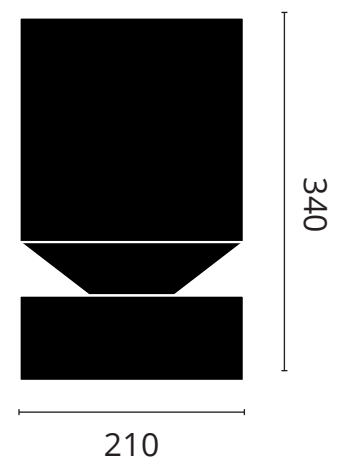
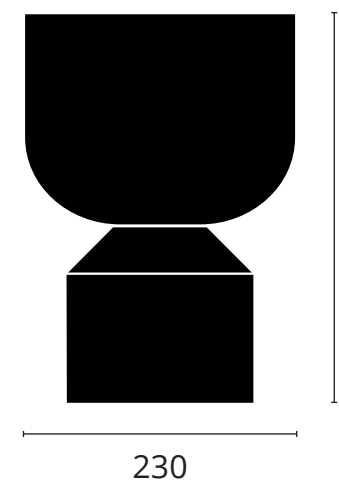
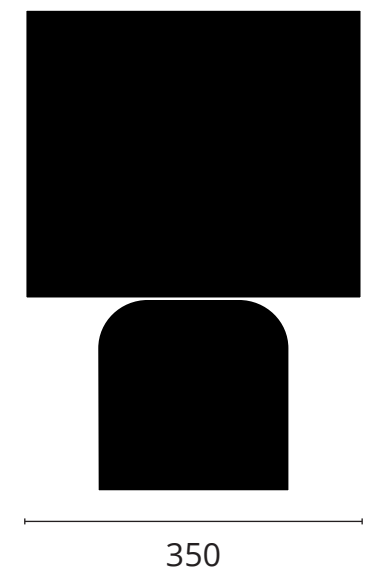
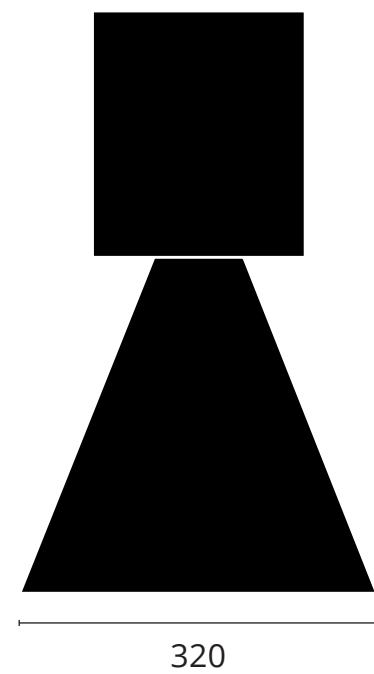



THE



The frame THEO puts pots from diameter 17 - 22 centimeter up in the air. Two stoppers made from cork are included. They are plugged into the hole in the bottom due to keep the roots well supplied with water and match any pot. Equipped with a 150 centimeter long rope, THEO allows adjusting the height dynamically.





The three THEOS are exoskeletons for domestic flora. They come in triangle, square and circle and are designed to hold differently sized potted plants. The simple geometric shapes merge different functions. THEO frames the greens, protects them and gives them hold while growing.



THEO	
description:	plant hanger
material:	steel
surface:	powder coated
colours available :	black
made in:	poland
production:	100% hand made
availability:	in stock
years of development:	2015
design:	llo t llov
website:	www.llo t llov.com
hanger:	circle
measurements:	1100mm x 510mm x 170mm
weight:	500 gramm
hanger:	triangle
measurements:	1100mm x 579mm x 179mm
weight:	500 gramm
hanger:	squared
measurements:	1100mm x 495mm x 170mm
weight:	500 gramm

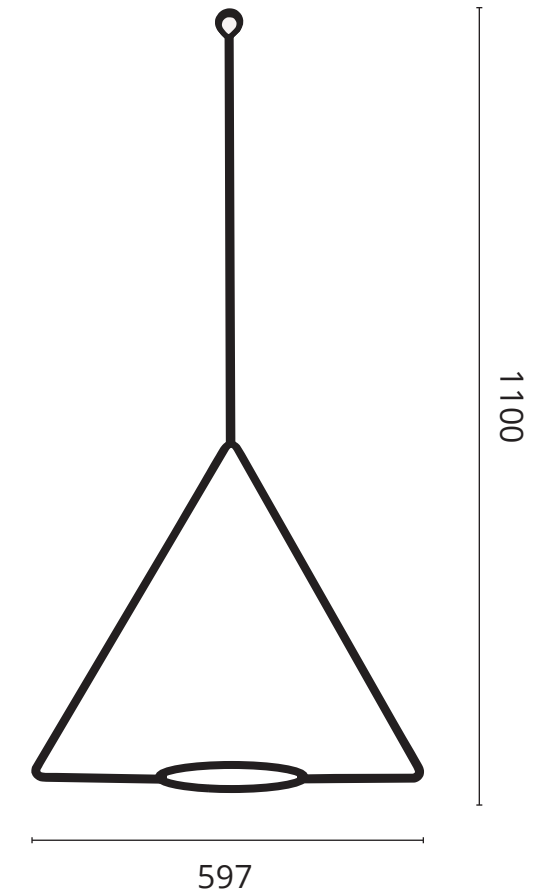
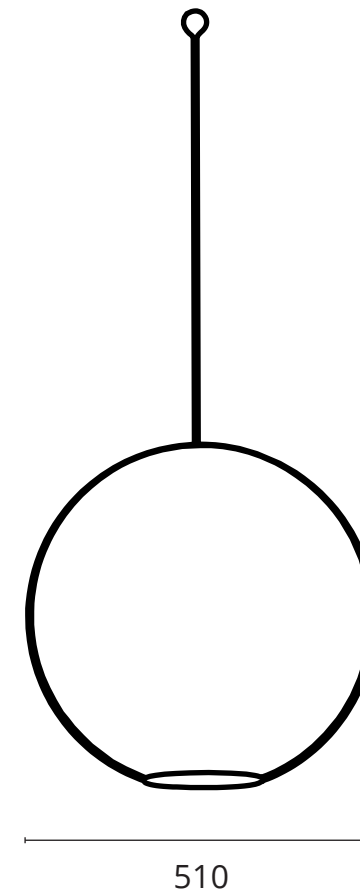
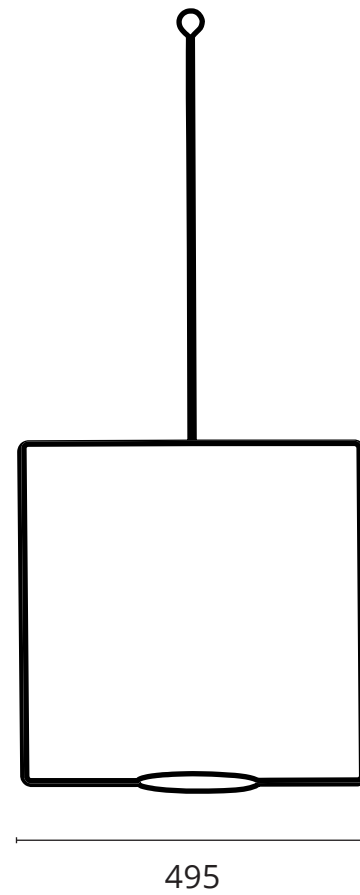

**LUCKY**

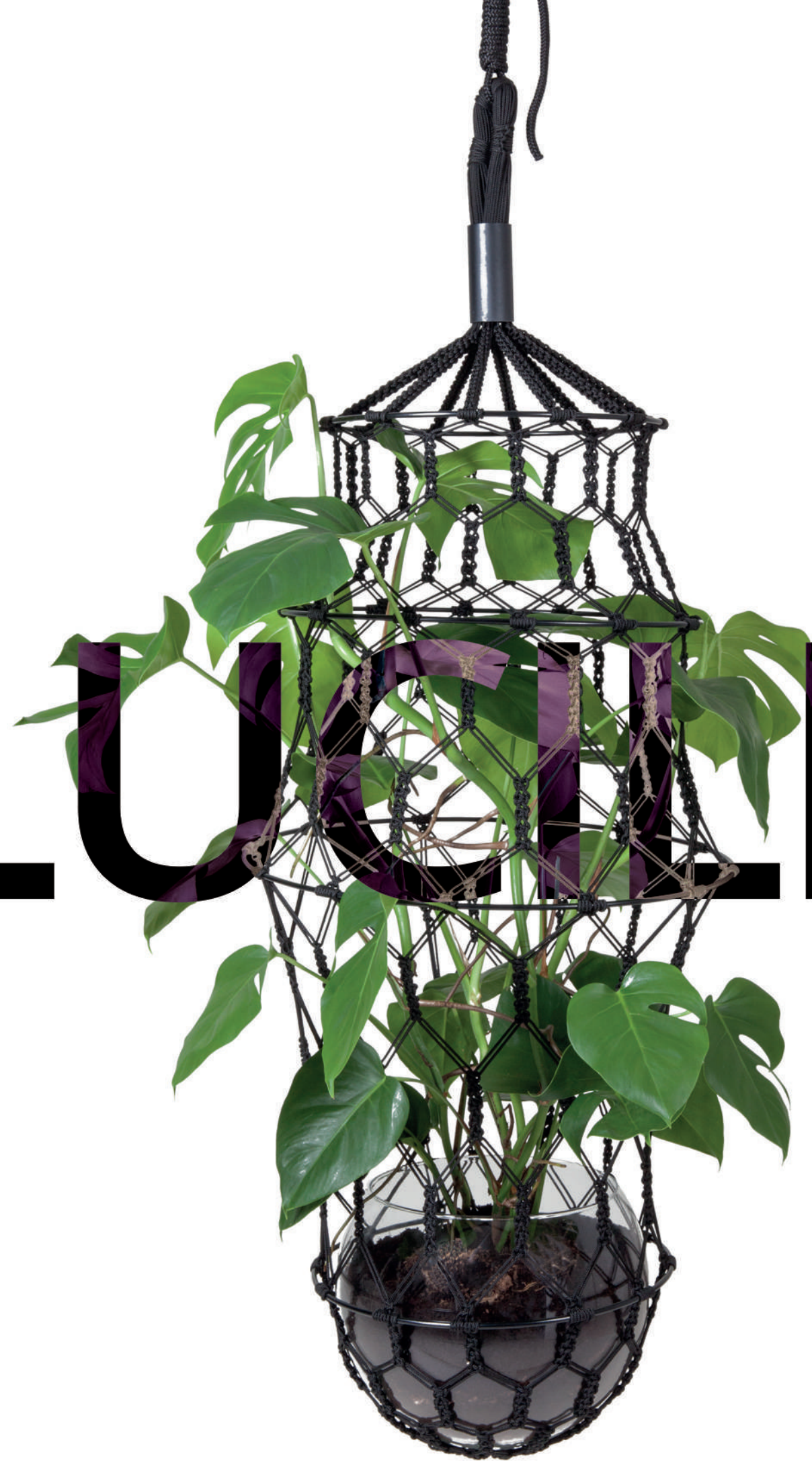

**LE**



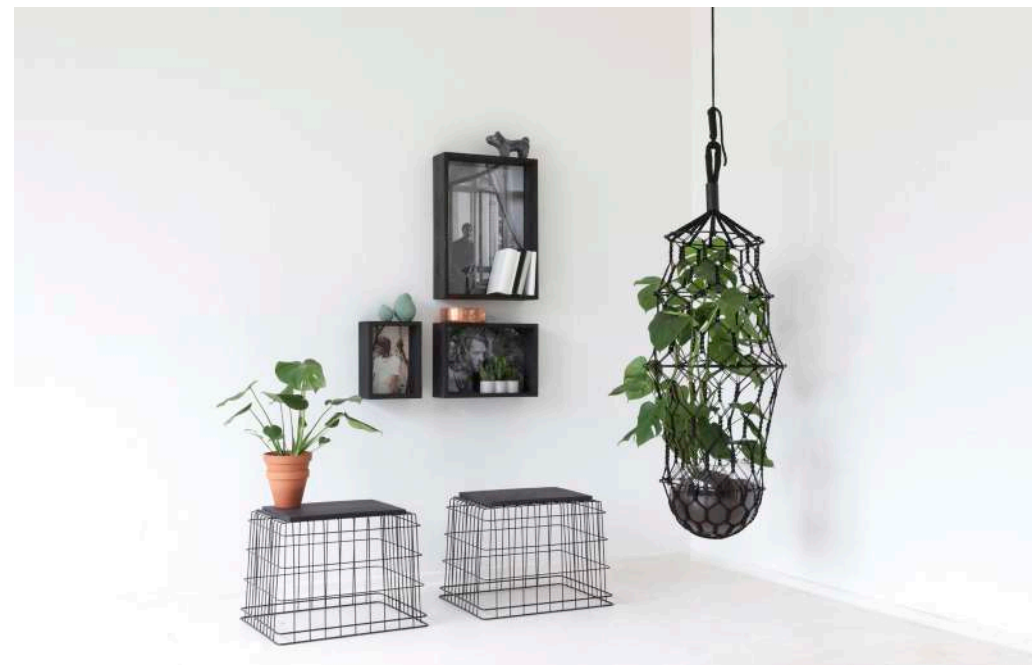

Less is a bore when it comes to the domestic jungle. LUCILLE is a contemporary interpretation of a hanging plant basket and organizes our lush indoor greenery.

The knotted structure is adapted from the traditional macramé but converted for our modern needs. While conventional flower nets end in a bunch of loose ends, LUCILLEs construction is turned upside down and the ropes are bundled at the top. The noose serves as a hanging loop and the hoist also modifies the height.

With its big meshes and without curlicues, the airy cocoon leaves room for the plant to develop and serves as a climbing aid. Looking up from beneath we can see the usually hidden natural processes. Earth and roots are visible through the bottom of the hand-blown glass flowerpot.



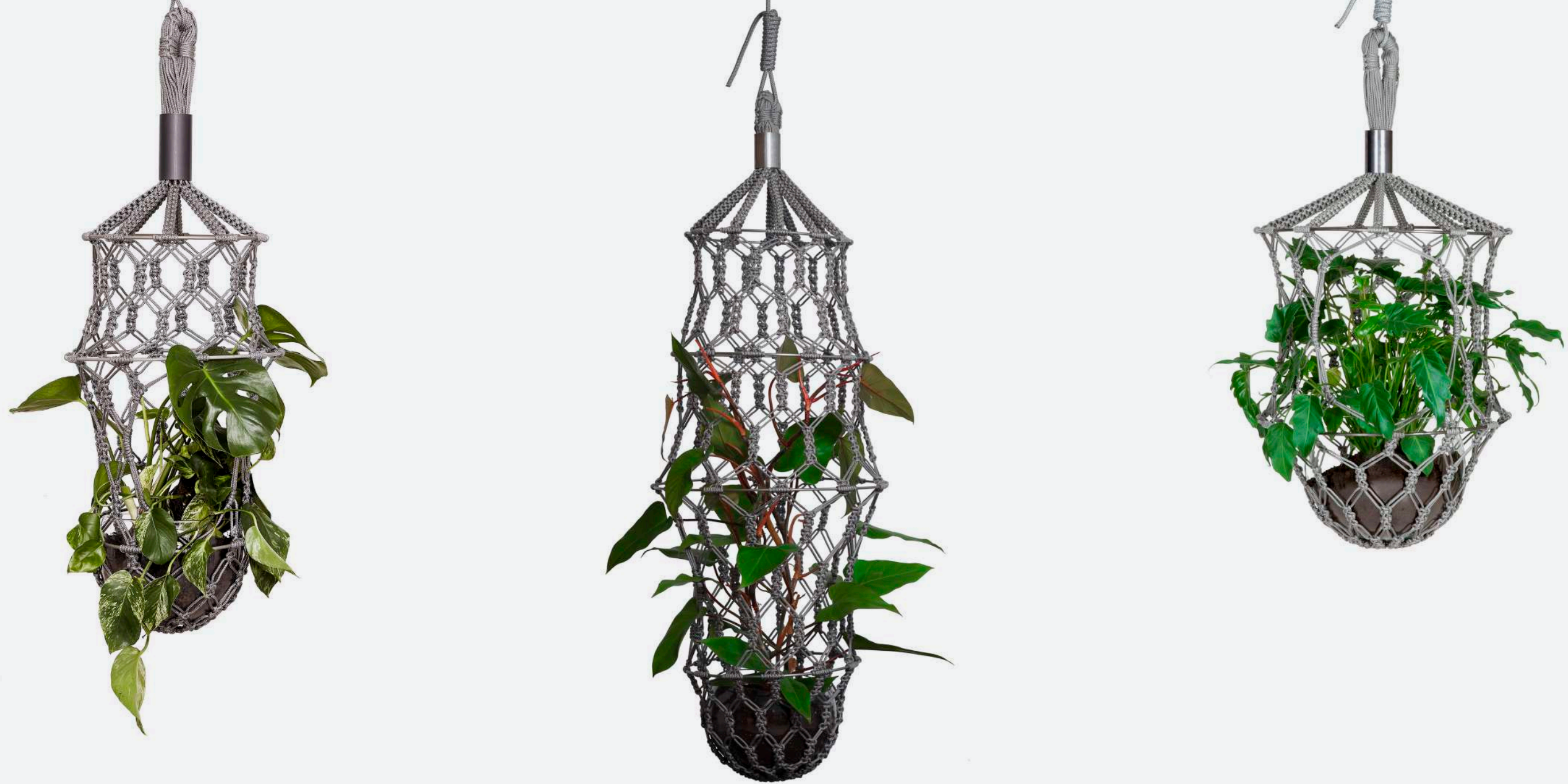

The production and assembly of LUCILLE is a collaboration with Dobbins and Daughters, a socially responsible fashion company that closely cooperates with young Latvian mothers. The corporate concept allows them to work from home and finish the handcrafted pieces as it fits their schedule. Each piece is made by hand and slightly different. If you wish to select a certain colour, please contact us.



LUCILLE	
description:	flower cocoon
material:	steel, nylon, glass
including:	glas globe
colours available :	grey, black, nature
made in:	latvia
production:	100% hand made
availability:	in stock
years of development:	2009 / 2015
design:	Ilot Ilov
website:	www.IlotIlov.com
cocoon:	grand
measurements:	540mm x 1550 mm
weight:	5 kg
cocoon:	petit
measurements:	540mm x 800mm
weight:	3 kg
cocoon:	bold
measurements:	400mm x 900mm
weight:	4 kg

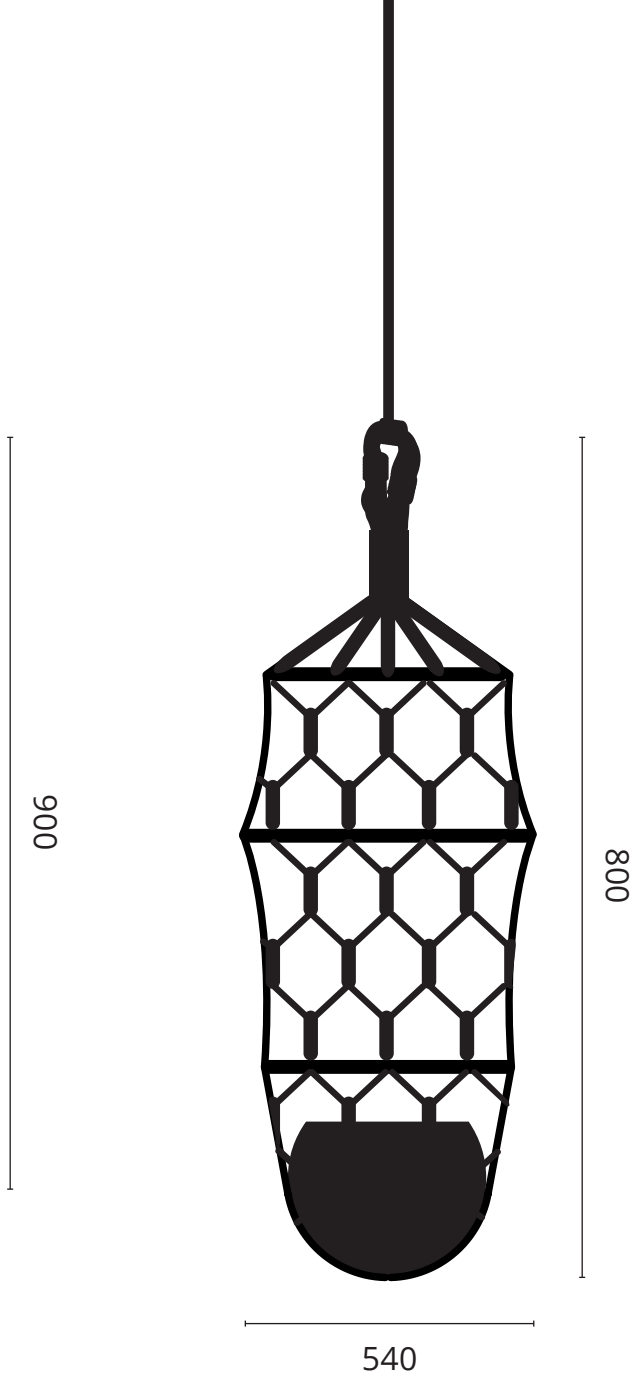
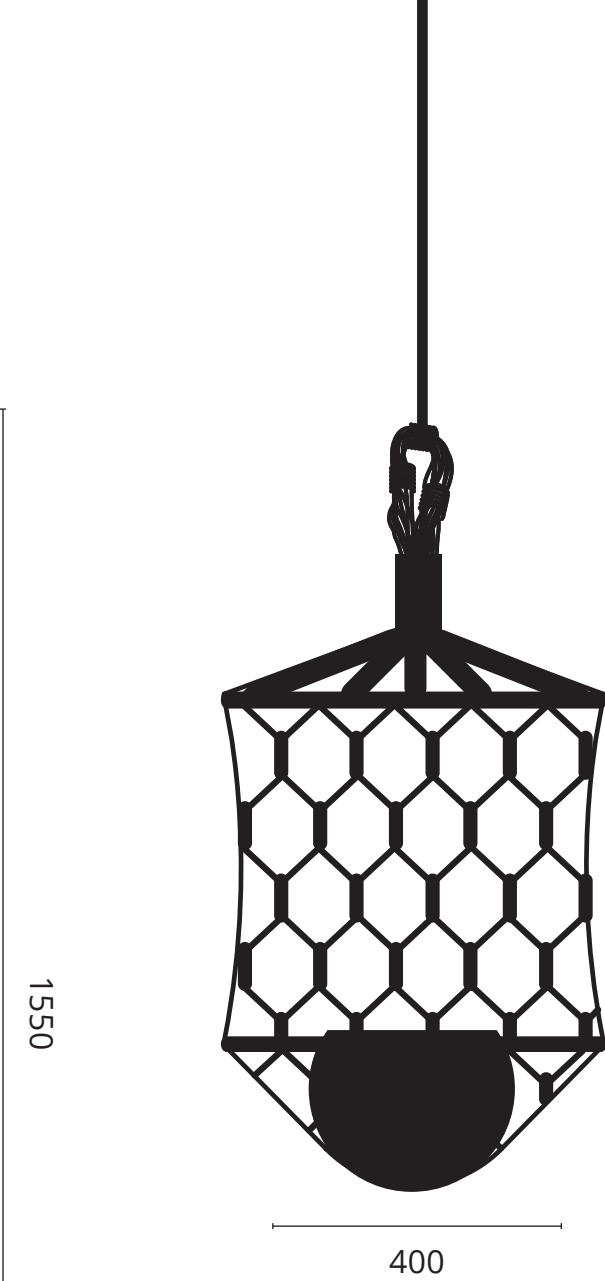
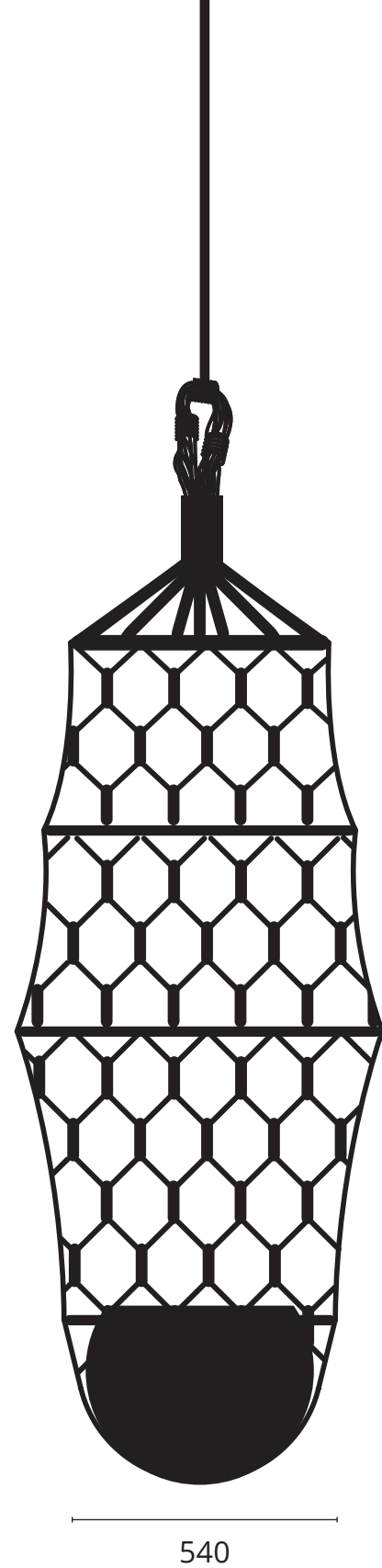



**IDA**



Ivita, Dace and Agnes, IDA for short, are based on weaving and macramé techniques and literally take LUCILLE one step further. The two rope ladders were developed in Ilot Ilov's Berlin studio and then finalised for production during a workshop held with the women in Riga. They are not only made for climbing higher, but also house your everyday objects in the hallway, office or living room.







IDA	
description:	ladder
material:	ash wood, nylon
including:	
colours available :	blue, nature
made in:	latvia
production:	100% hand made
availability:	in stock
years of development:	2014
design:	Ilot Ilov
website:	www.IlotIlov.com
ladder:	agnes
measurements:	1570mm x 800mm
weight:	2 kg
ladder:	dace
measurements:	1830mm x 300mm
weight:	3 kg
ladder:	ivita
measurements:	1950mm x 300mm
weight:	2 kg

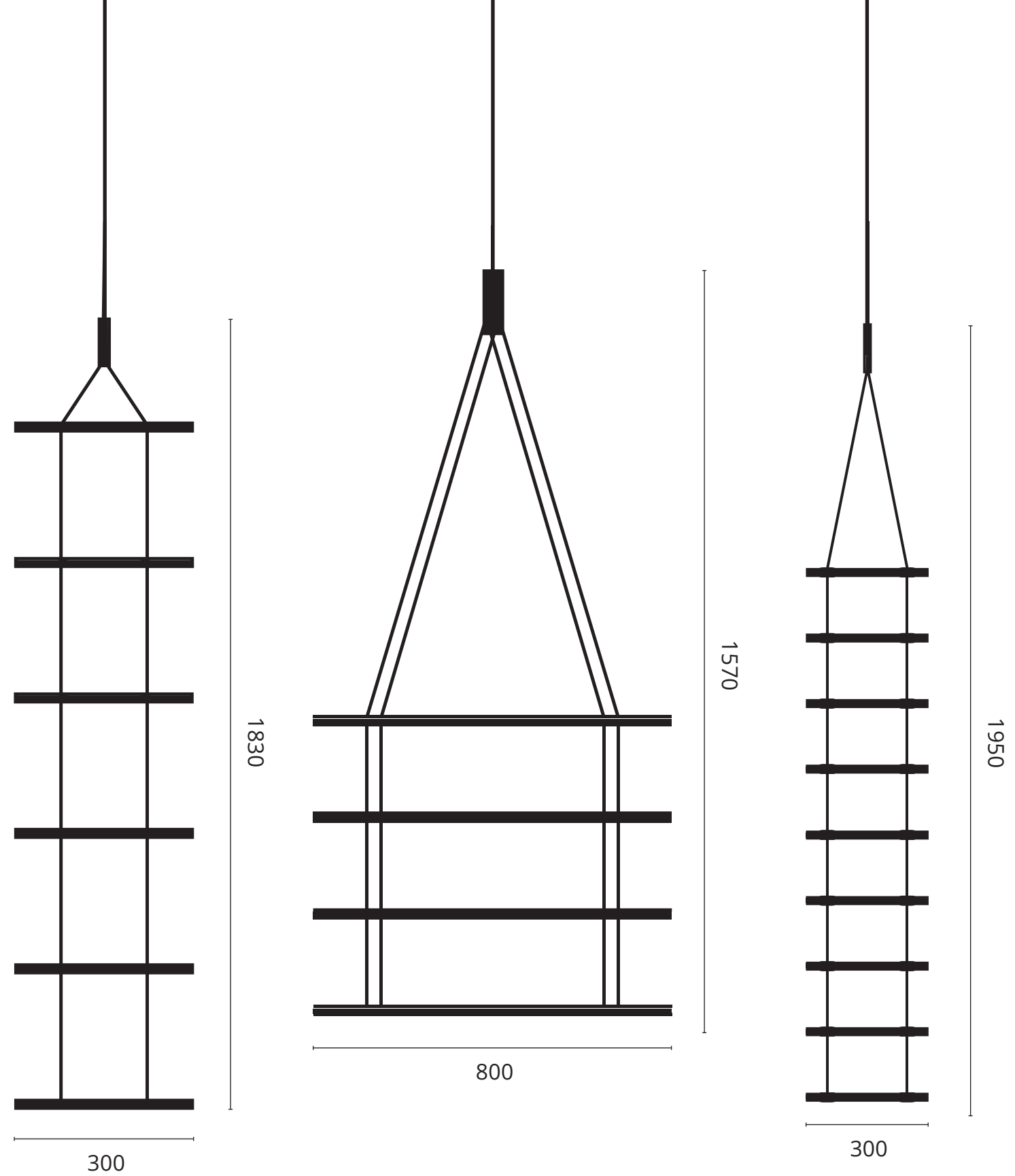



**HANK**

3.1 -

Antik



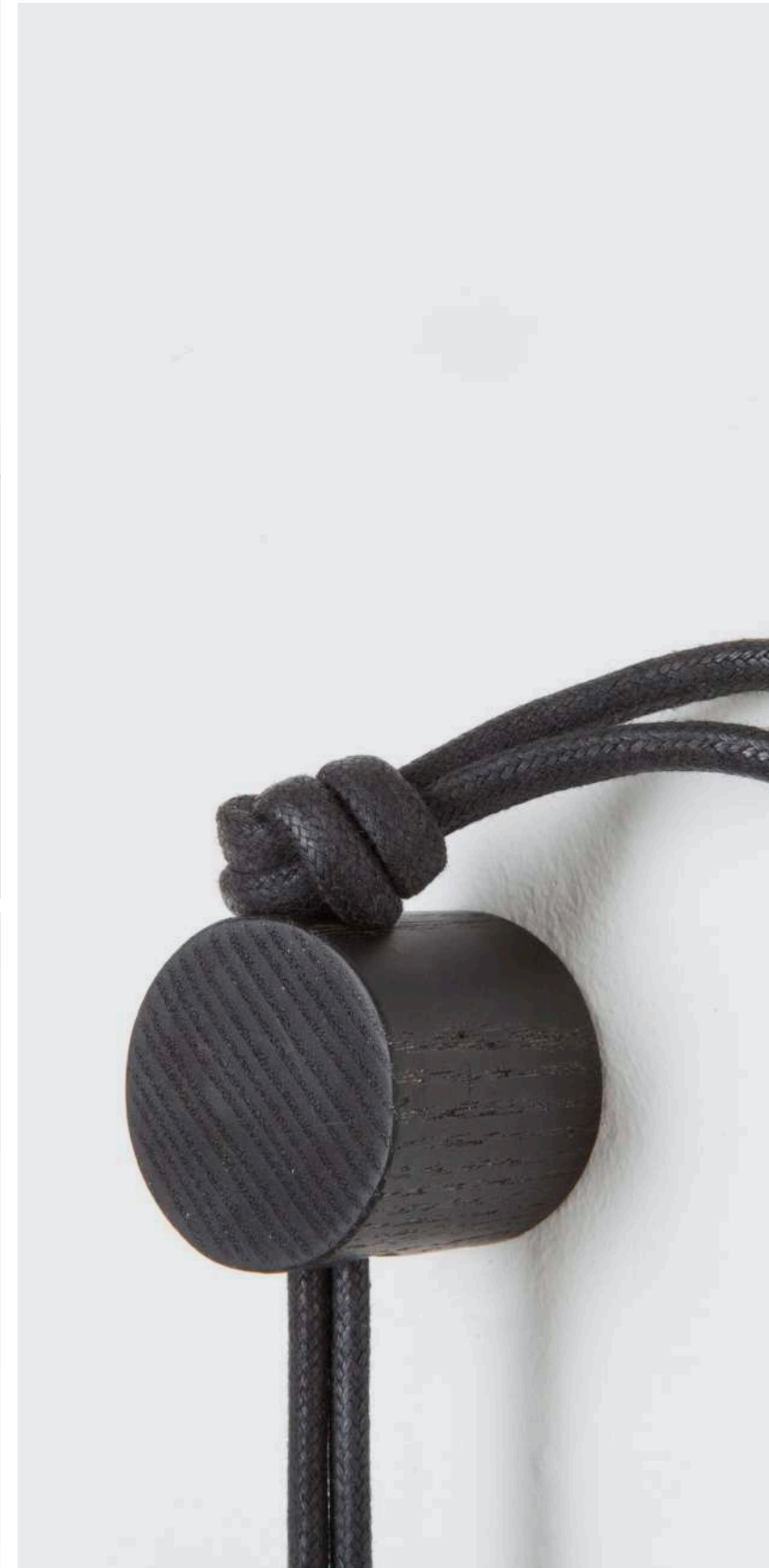
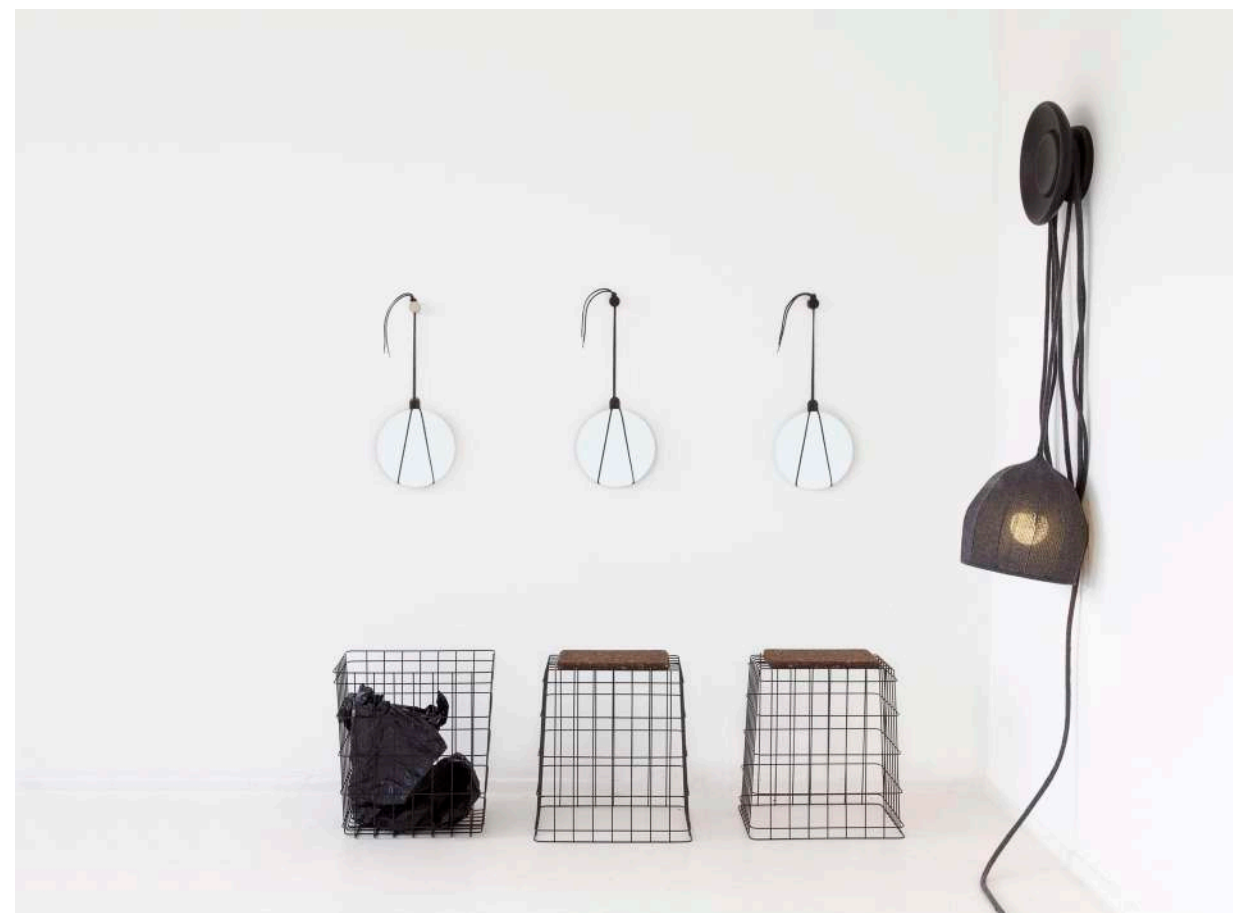

Discover your hidden reserves – explore your attics, examine your basements and collect all glass that reflects – Ilot Ilov is on a mission to reanimate every single ancient mirror that lies around.

Through HANK abandoned mirrors regain their place on the wall. The product itself consists of a harness made of waxed cotton rope, a wooden knob and a small aluminum plate. The rope is set up in a v-shape and adjusted by the plate, which sits on the mirror's upper edge. Here the ropes merge and lead to the wooden knob that holds the minimalist installation parallel to the wall.

This knob needs just one drill hole to be fastened and with its reduced parts HANK is clever and light. The set comes in two versions that cover literally every size and shape.



HANK consists of a few parts. The Aluminum plates are made in China. The cotton rope is from Spain and the wooden knobs are produced by a wood turnery in Poland. All parts are assembled at Vfj Werkstätten in Berlin.



HANK	
description:	mirror hanger
material:	ashwood, aluminum, cotton
including:	mirror is not included
colours available :	black/black, black/nature, nature/nature
made in:	germany
production:	100% hand made
availability:	in stock
years of development:	2014
design:	Ilot Ilov
website:	www.IlotIlov.com
hanger:	large
length:	1920mm
mirror size:	max Ø 700 mm
hanger:	small
length:	1220mm
mirror size:	max Ø 400 mm

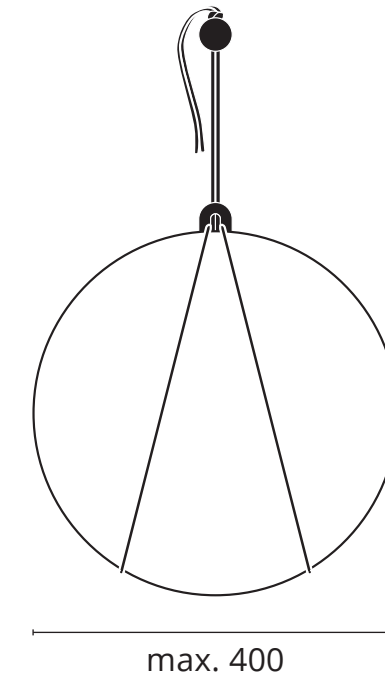
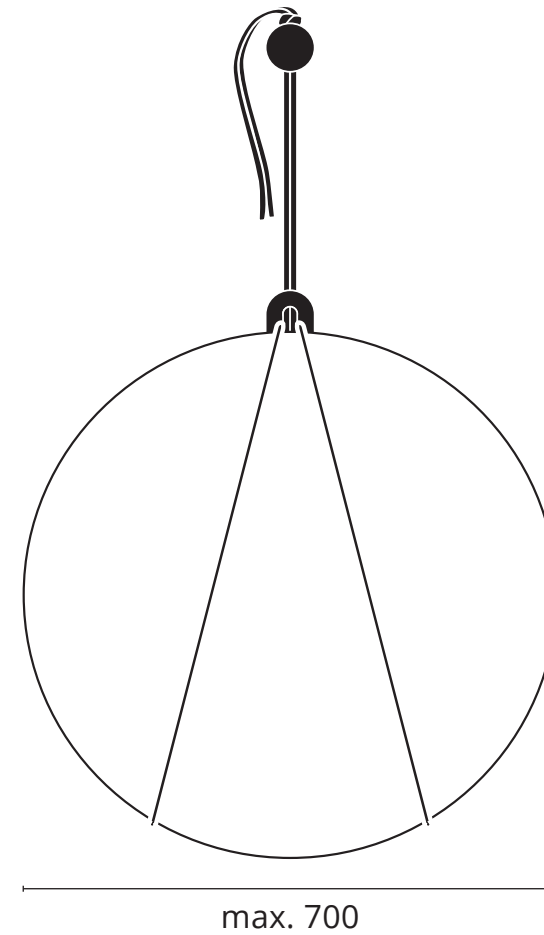



**TEA**





The three sculptures TEA - THOMAS, EDISON and ALVA offer an arty alternative to decorate a wall. Their eccentric shapes have been adapted from high voltage insulators. Usually, these are made out of ceramic to isolate the fixing of electrical conductors. The wall knobs function as a wardrobe. They can be individually placed and combined with each other in many ways. Without covers, their varying structures create dynamic shapes on the wall. Besides their ability to hang clothes and present themselves in a sculptural way on the wall, they are a product designed in addition to our lamp MATT. One can wrap MATT around the wall knobs, fixing them on the wall. The knobs are packed singly and can be bought separately.



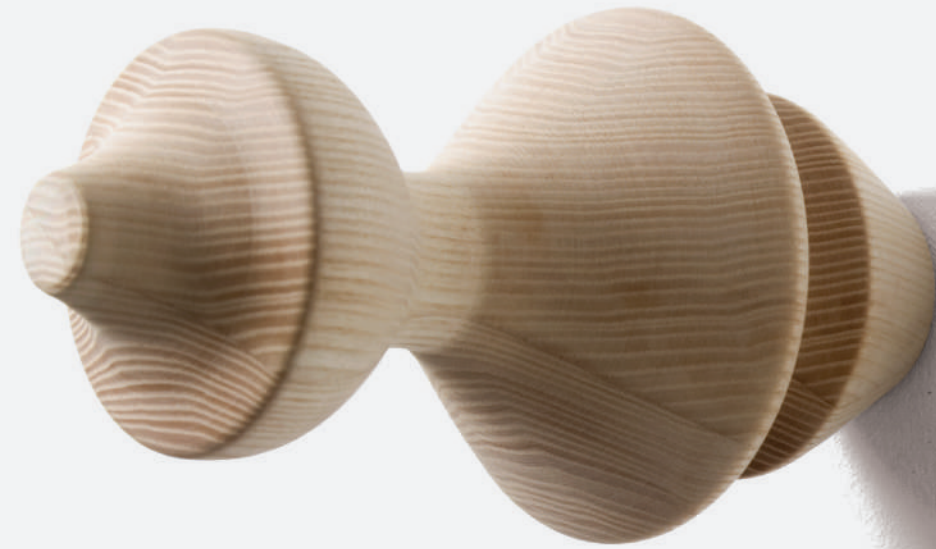

Due to its unusual size, TEA THOMAS also serves as an easy and practical alternative to a clothes hanger. It is available in black. With its delicate shape, TEA EDISON can also function to hook a hanger. It is made out of ash wood, which gives the technical shape an almost feminine touch. TEA ALVA has a soft white surface and therefore stands out. The pieces are hand-turned by a traditional woodturner in Erzgebirge. The area is famous for handicrafts. Each piece is slightly different.



TEA	
description:	wardrobe knob
material:	ash wood
including:	
colours available :	black, white, nature
made in:	germany
production:	100% hand made
availability:	on request
years of development:	2010
design:	Ilot Ilov
website:	www.IlotIlov.com
wardrobe knob:	thomas
measurements:	330mm x 140mm
weight:	1,5 kg kg
wardrobe knob:	alva
measurements:	190mm 150mm
weight:	1 kg
wardrobe knob:	edison
measurements:	110mm x120mm
weight:	800 gramm

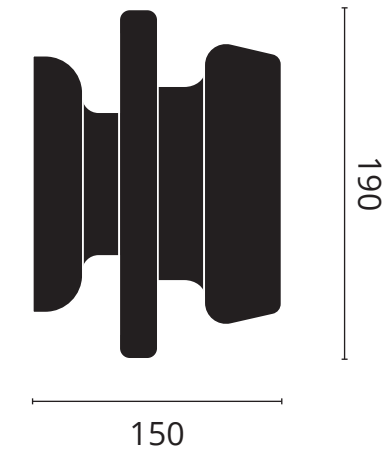
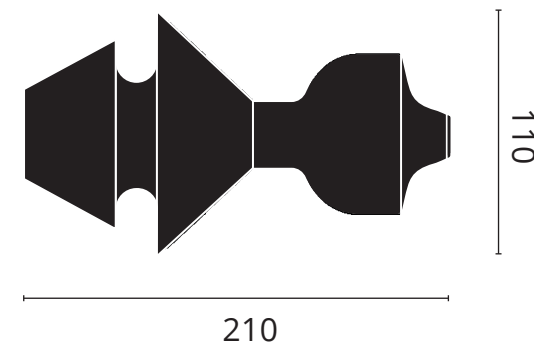
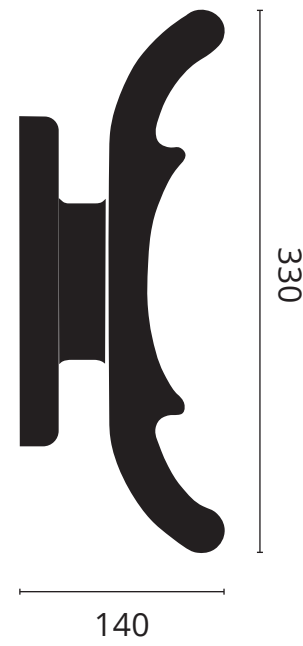

**HOLD**







HOLD is a wall mount that keeps a standard E27 socket in its position. It's an easy way to make a simple ceiling lamp solution into a wall light. HOLD is made of silicone and available in 4 colours.





HOLD	
description:	lamp wall mount
material:	silicone
including:	
colours available :	natural, black, silk grey, pastel turquoise
made in:	china
production:	100% hand made
availability:	in stock
years of development:	2015
design:	Ilot Ilov
website:	<a href="http://www.IlotIlov.com">www.IlotIlov.com</a>
lamp wall mount:	hold
measurements:	190mm x 150mm x 150mm
weight:	200 g





A collection of colorful, knotted ropes in shades of blue, orange, and grey, with the word 'MATT' overlaid in large black letters. The ropes are arranged in a vertical, slightly chaotic manner, with some knots and loops visible. The background is a plain, light color. The text 'MATT' is centered horizontally and vertically, with a slight shadow effect behind the letters.

**MATT**



MATT is a lighting element with the ability to dynamically adapt itself according to the individual needs of its user, changing its appearance with the place of installation. Hung as a single piece, knotted in a group or set on a hook on the wall: MATT simply fits into the scene of its placement, flexibly draping itself to the shape and situation of a room. The fluffy woven fabric of the knitting hides the sober technology within (like cables and socket) and evokes the impression of ropes meeting and melting into each other. The energy-saving bulb used for Matt radiates a warm, glowing light.





The yarns used for MATT are imported from Italy and knitted in Bavaria. A computerized knitting machine produces the knitted cable-cover of the light. The electric pieces are first put together, then threaded through the knit-ware by disabled people in a Berlin workshop (Vfj Werkstätten). The Merino yarn used on MATT is 100% pure. In its structure it is smooth and hardly hairy. The knitting is soft and dense.



MATT	
description:	knitted lamp
material available:	merino, angora, cotton
including:	light bulb
colours available :	mouse, azul, stop, day, night, rock, inga, graphit
made in:	germany
production:	100% hand made
availability:	in stock
years of development:	2008
design:	Ilot Ilov
website:	www.IlotIlov.com
knitted lamp:	matt
measurements:	Ø 15 x 12000 mm
weight:	1,5 kg

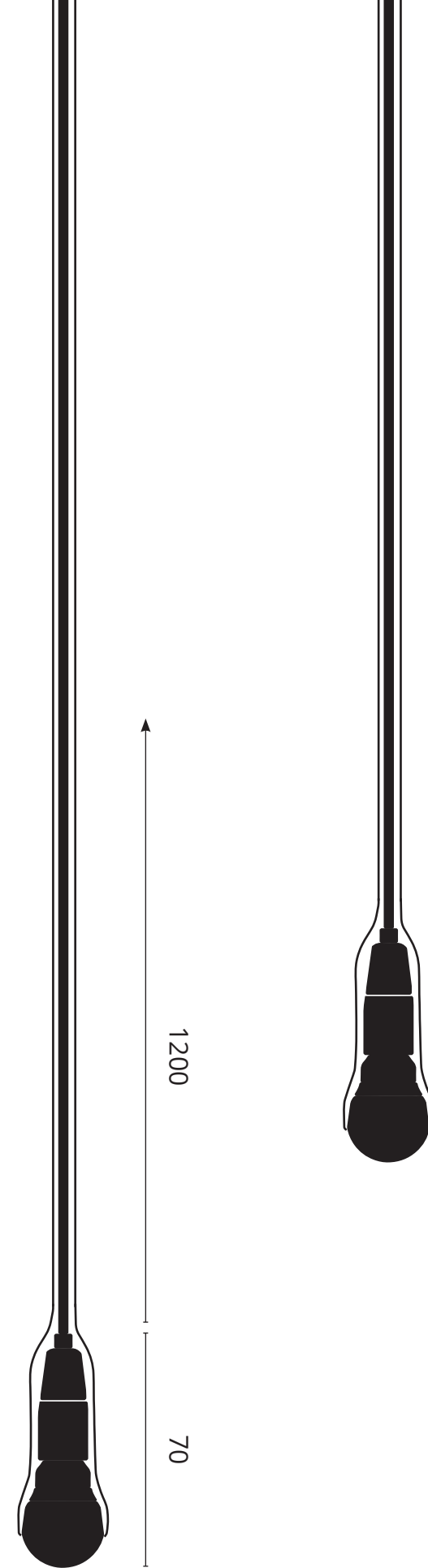



**R**  
**R** **M**  
**M**





RAY is a lamp that has the capability to follow its owner on his/her heel. The cable of a hanging lamp is prolonged by 12 meters, thus enabling RAY to become a lying, hanging or atmospheric lamp. The possibilities for using the device are unlimited, adapting to any method of playful arrangement. The fluffy woven fabric of the knitting hides the sober technology within (like cables, socket and shade). The energy-saving bulb used for RAY radiates a warm, glowing light.





RAY hangs on to things, wraps objects together, follows the user to where it is needed, forming sculptures as it goes. In this way, the lamp combines the essentials of Ilot Ilov, who always aim to involve the user as a designer. RAYs lampshade and the 12 meters of cable are covered by knitted merino wool. Due to this choice of material, it is intended to serve as a main source of light over a dinner table or in the designated reading corner. Used as a wall-mounted lamp, winding lamp, knotted or just lightly slung over the back of a chair- this lamp is made to create lighting space on a high aesthetic level whilst providing complete flexibility in adjusting to ones personal changing needs.



RAY	
description:	pendant light
material available:	merino, angora
including:	light bulb
colours available :	mouse, graphit, coyote, inga
made in:	germany
production:	100% hand made
availability:	in stock
years of development:	2008
design:	llo t llov
website:	www.llotllov.com
pendand lamp:	ray
measurements:	300mm x 330mm x 12000 mm
weight:	2 kg

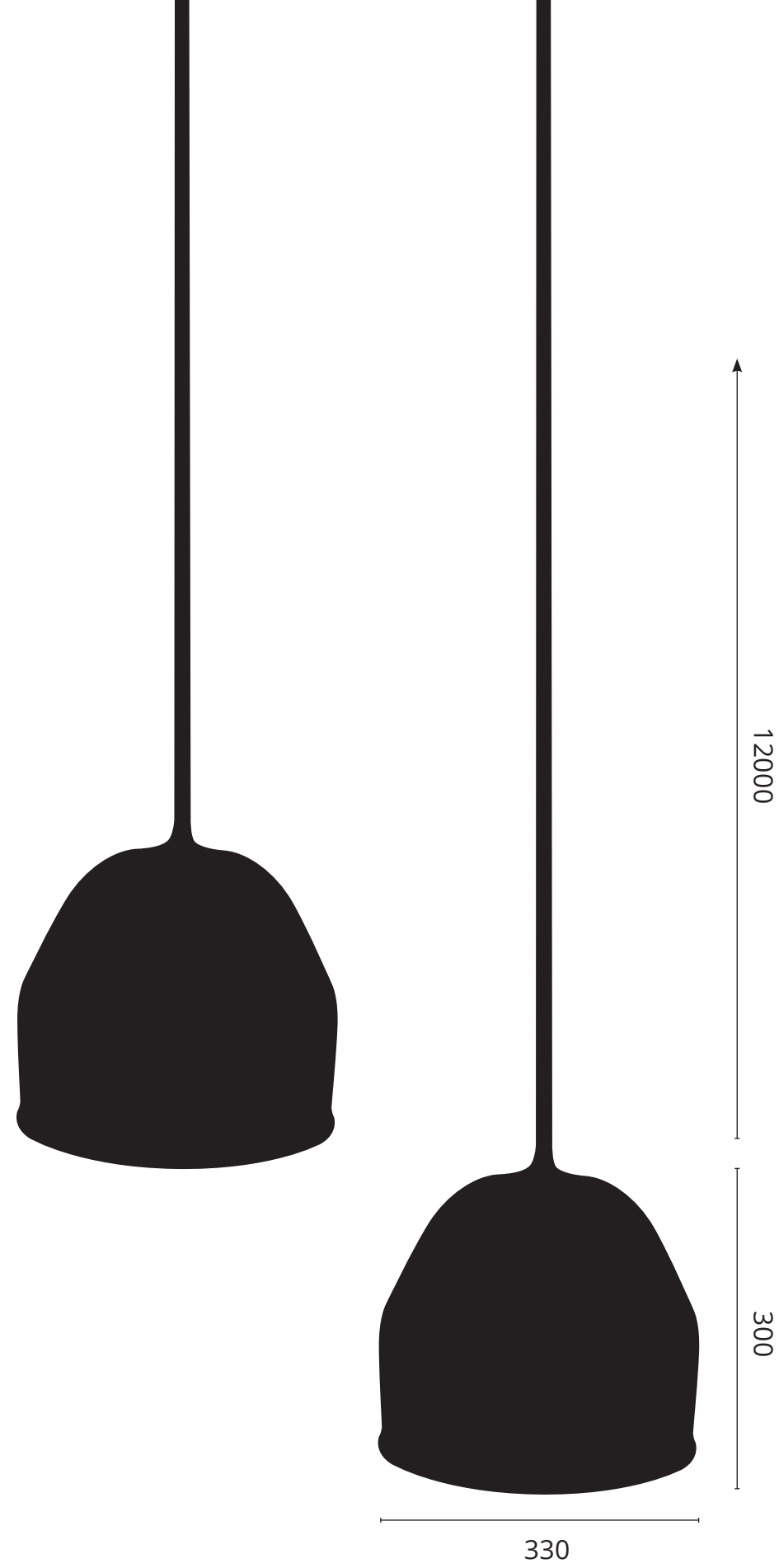



**EARL**



EARL is a flexible light that is convincing through its simple, but a dynamic system. The wooden pearls threaded on a cable act as levels in order to adjust the illuminating object. A hook locates the light source to any desired position. This provides an easy method of changing height and orientation, which enables a wide variety of implementation. The led light source is embedded into the biggest pearl at the end of the thread. The silicone shade is pushed onto this pearl without being fixated. Similar to a spherical joint, the silicone shade can be moved into different directions.

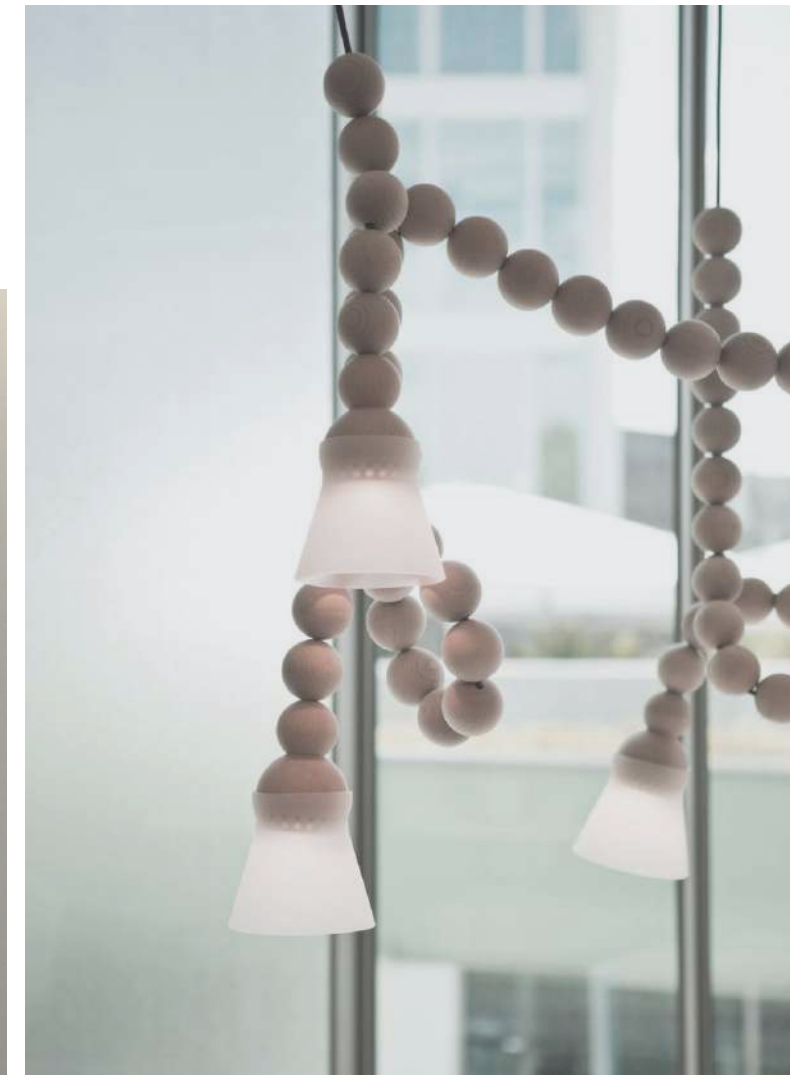



Each wooden pearl is marbled at Ilot Ilov design studio. The pieces are hand-turned by a woodturner in Poland. Each piece is slightly different.



EARL	
description:	pendant light
materials:	beech wood, steel, silicon
including:	light bulb
colours available :	nature, nature/marbled black
made in:	germany
production:	100% hand made
availability:	in stock
years of development:	2011, 2013
design:	llo t llov
website:	<a href="http://www.llo t llov.com">www.llo t llov.com</a>
pendand lamp:	earl
measurements:	Ø 243mm x 1500 mm
weight:	2 kg

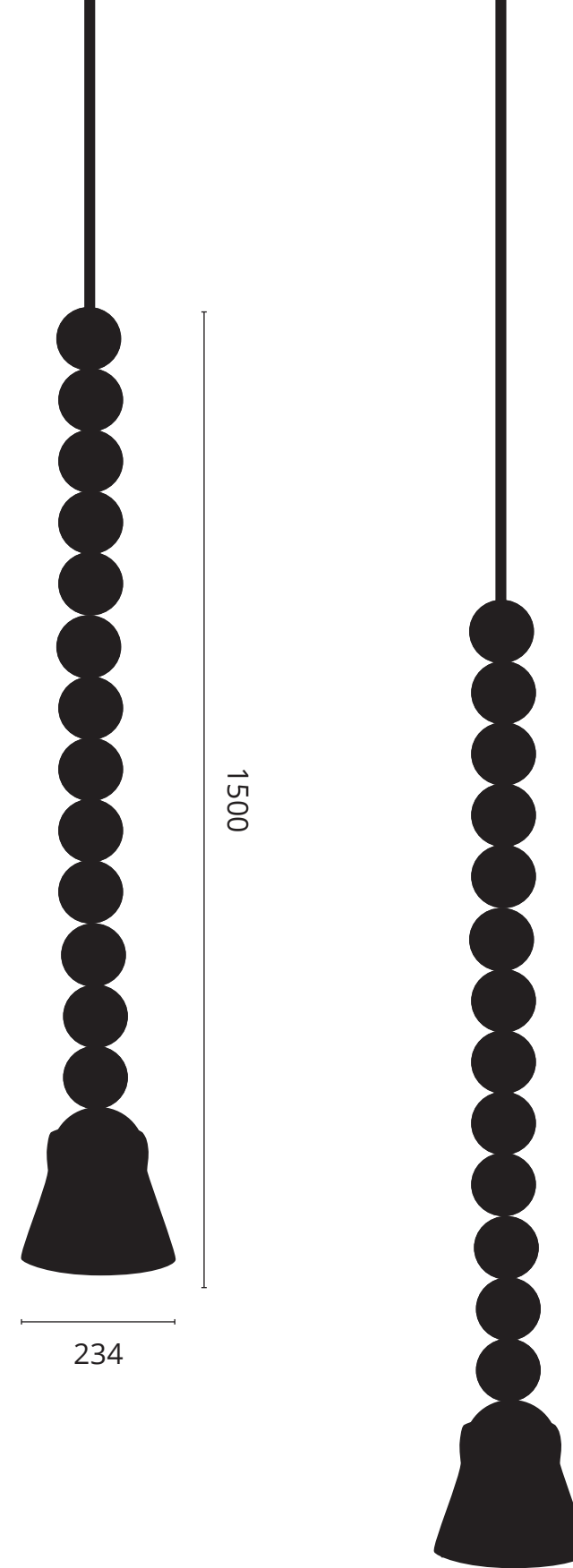



**GRIT**



The stool GRIT stool with its thin wiring has the appearance of a delicate drawing. The cross-wiring resembles a steel basket and offers due to the many connecting points a lot of stability. To enhance sitting comfort a cork seat with the grit of the wiring on the underside can be added. GRIT can be stacked and is equally suited for indoors and outdoors.





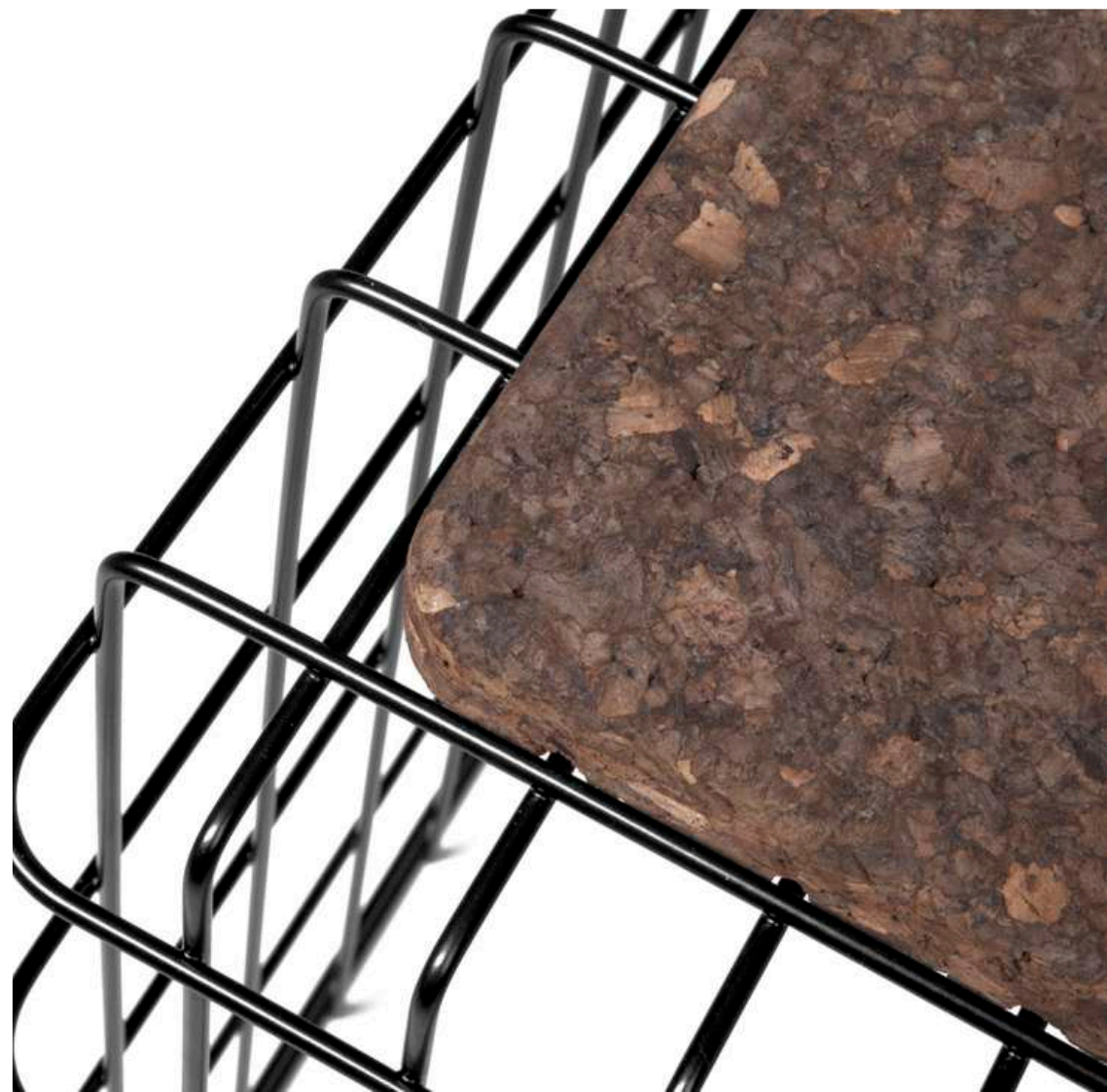
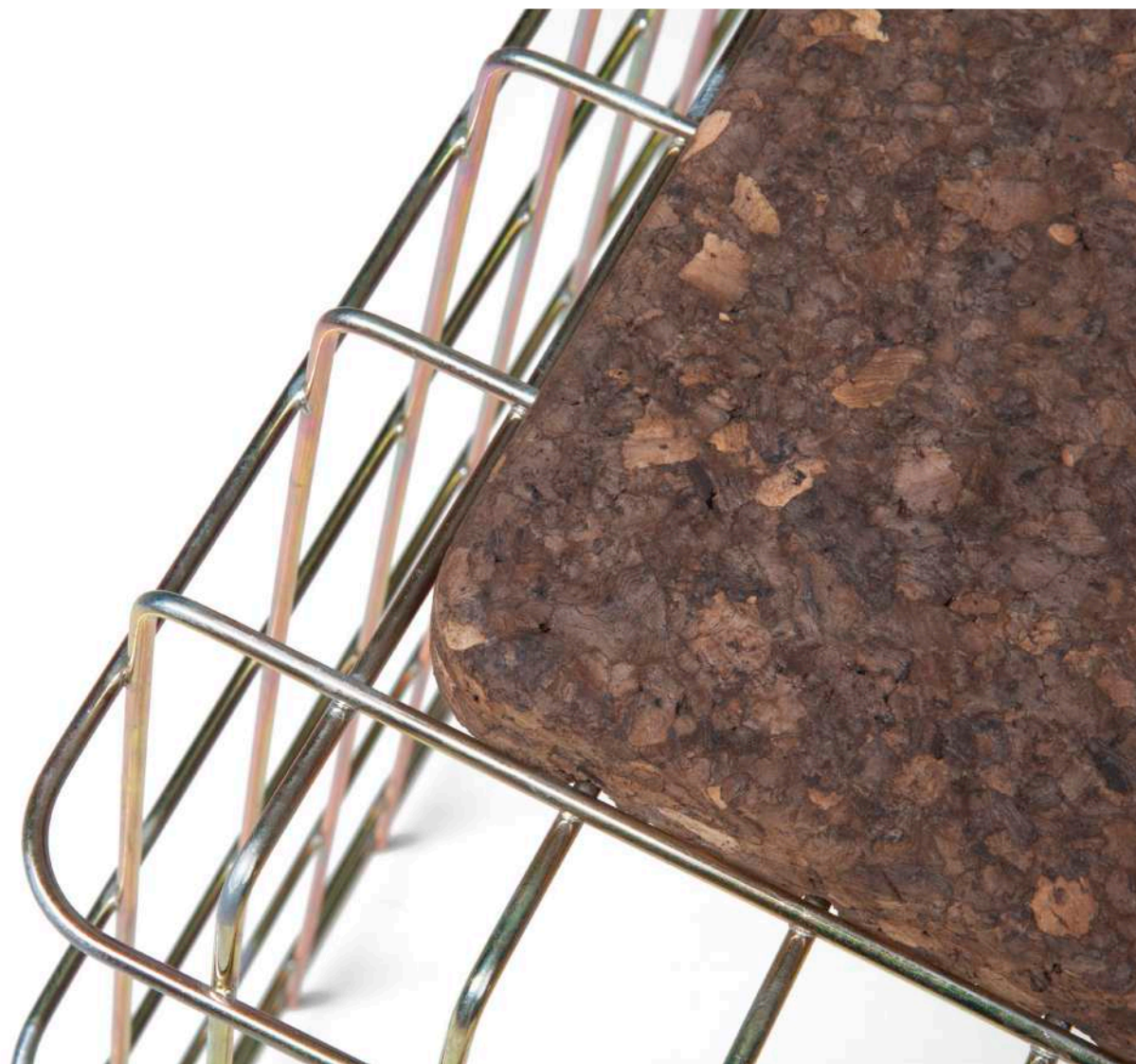



GRIT	
description:	stool
materials:	powder coated steel, cork
including:	cork pad
colours available :	black, grey, red, white
made in:	poland
production:	100% hand made
availability:	in stock
years of development:	2013
design:	llo t llov
website:	www.llo t llov.com
stool:	grit
measurements:	460mm x 496mm x 340mm
weight:	3 kg

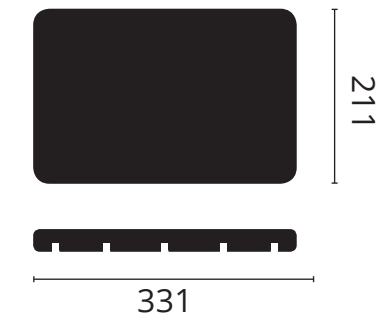
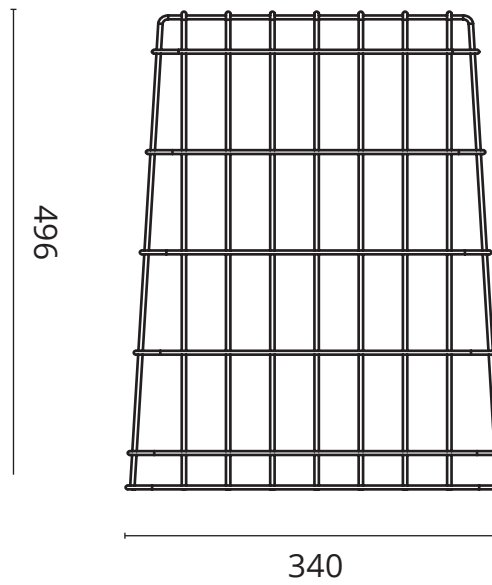
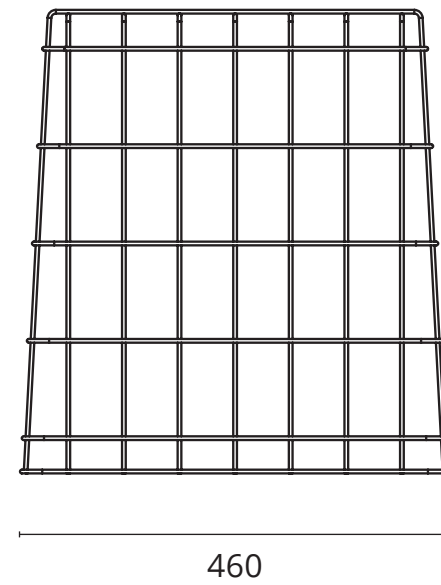



Product: Medeia Bold  
 Art No: GVC01  
 Colour: white  
 RRP: 150,00 €



Product: Medeia Slim  
 Art No: GVR01  
 Colour: white  
 RRP: 135,00 €



Product: Medeia Midi  
 Art No: GVT01  
 Colour: white  
 RRP: 125,00 €



Product: Medeia Bold  
 Art No: GVC05  
 Colour: raw  
 RRP: 150,00 €



Product: Medeia Slim  
 Art No: GVR05  
 Colour: raw  
 RRP: 135,00 €



Product: Medeia Midi  
 Art No: GVT05  
 Colour: raw  
 RRP: 125,00 €



Product: Medeia Bold  
 Art No: GVC02  
 Colour: black  
 RRP: 150,00 €



Product: Medeia Slim  
 Art No: GVR02  
 Colour: black  
 RRP: 135,00 €



Product: Medeia Midi  
 Art No: GVT02  
 Colour: black  
 RRP: 125,00 €



Product: Ada Bold  
 Art No: RCC01  
 Colour: black  
 RRP: 290,00 €



Product: Ada Large  
 Art No: RTC01  
 Colour: black  
 RRP: 200,00 €



Product: Ada Midi  
 Art No: CTC01  
 Colour: black  
 RRP: 170,00 €



Product: Ada Small  
 Art No: TRC01  
 Colour: black  
 RRP: 170,00 €



Product: Medeia Bold  
 Art No: GVC03  
 Colour: blue  
 RRP: 150,00 €



Product: Medeia Slim  
 Art No: GVR03  
 Colour: blue  
 RRP: 135,00 €



Product: Medeia Midi  
 Art No: GVT03  
 Colour: blue  
 RRP: 125,00 €



Product: Ada Bold  
 Art No: RCC02  
 Colour: raw  
 RRP: 290,00 €



Product: Ada Large  
 Art No: RTC02  
 Colour: raw  
 RRP: 200,00 €



Product: Ada Midi  
 Art No: CTC02  
 Colour: raw  
 RRP: 170,00 €



Product: Ada Small  
 Art No: TRC02  
 Colour: raw  
 RRP: 170,00 €



Product: Medeia Bold  
 Art No: GVC04  
 Colour: pigeon  
 RRP: 150,00 €



Product: Medeia Slim  
 Art No: GVR04  
 Colour: pigeon  
 RRP: 135,00 €



Product: Medeia Midi  
 Art No: GVT04  
 Colour: pigeon  
 RRP: 125,00 €



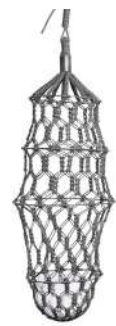

Product: Lucille Grand  
 Art No: LN12  
 Colour: grey  
 RRP: 630,00 €



Product: Lucille Grand  
 Art No: LN14  
 Colour: black  
 RRP: 630,00 €



Product: Lucille Grand  
 Art No: LN15  
 Colour: nature  
 RRP: 780,00 €

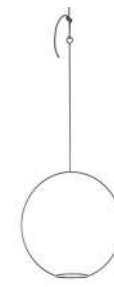

Product: Theo Circle  
 Art No: TC01  
 Colour: black  
 RRP: 95,00 €

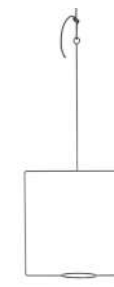

Product: Theo Square  
 Art No: TS01  
 Colour: black  
 RRP: 95,00 €



Product: Theo Triangle  
 Art No: TT01  
 Colour: black  
 RRP: 95,00 €



Product: Lucille Bold  
 Art No: LB12  
 Colour: grey  
 RRP: 490,00 €



Product: Lucille Bold  
 Art No: LB14  
 Colour: black  
 RRP: 490,00 €



Product: Lucille Bold  
 Art No: LB15  
 Colour: nature  
 RRP: 595,00 €



Product: Hank  
 Art No: HA01  
 Colour: black/black  
 RRP: 55,00 €



Product: Hank  
 Art No: HA03  
 Colour: beige /nature  
 RRP: 55,00 €



Product: Hank  
 Art No: HA05  
 Colour: black/nature  
 RRP: 55,00 €



Product: Lucille Petit  
 Art No: LP12  
 Colour: grey  
 RRP: 390,00 €



Product: Lucille Petit  
 Art No: LP14  
 Colour: black  
 RRP: 390,00 €



Product: Lucille Petit  
 Art No: LP15  
 Colour: nature  
 RRP: 475,00 €

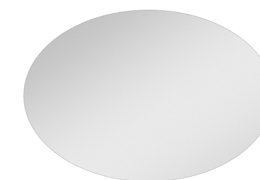

Product: Mirror Oval  
 Art No: M001  
 Colour: mirror glass  
 RRP: 76,00 €



Product: Mirror Squared  
 Art No: MS01  
 Colour: mirror glass  
 RRP: 55,00 €



Product: Mirror Round  
 Art No: MR01  
 Colour: mirror glass  
 RRP: 70,00 €



Product: Lucille Glas Globe  
 Art No: GL01  
 Colour: transparent  
 RRP: 35,00 €



Product: Lucille Glas Globe  
 Art No: GL02  
 Colour: transparent  
 RRP: 45,00 €



Product: IDA Dace  
 Art No: ID01  
 Colour: blue  
 RRP: 245,00 €



Product: IDA Agnes  
 Art No: IA01  
 Colour: blue  
 RRP: 285,00 €



Product: IDA Ivita  
 Art No: II01  
 Colour: blue  
 RRP: 285,00 €



Product: Corner Hooks  
 Art No: CH01  
 Colour: natural  
 RRP: 55,00 € (set of two)



Product: Corner Hooks  
 Art No: CH02  
 Colour: black  
 RRP: 55,00 € (set of two)



Product: GUR Pillow  
 Art No: GP01  
 Colour: multicolored  
 RRP: 245,00 €



Product: GUR Pillow  
 Art No: GP02  
 Colour: yellow/blue  
 RRP: 245,00 €



Product: TEA Thomas  
 Art No: TB01  
 Colour: black  
 RRP: 145,00 €



Product: TEA Edison  
 Art No: EN01  
 Colour: nature  
 RRP: 71,00 €



Product: TEA Alva  
 Art No: AW01  
 Colour: white  
 RRP: 120,00 €



Product: Grit Cork Pad  
 Art No: CC01  
 Colour: light  
 RRP: 45,00 €



Product: Grit Cork Pad  
 Art No: CC02  
 Colour: dark  
 RRP: 45,00 €



Product: Hold  
 Art No: HD01  
 Colour: natural  
 RRP: 23,00 €



Product: Hold  
 Art No: HD02  
 Colour: black  
 RRP: 23,00



Product: Hold  
 Art No: HD03  
 Colour: silk grey  
 RRP: 23,00



Product: Hold  
 Art No: HD04  
 Colour: pastell turquoise  
 RRP: 23,00 €



Product: Grit  
 Art No: GS01  
 Colour: black  
 RRP: 185,00 €



Product: Grit  
 Art No: GS02  
 Colour: grey  
 RRP: 185,00 €



Product: Grit  
 Art No: GS03  
 Colour: red  
 RRP: 185,00 €



Product: Grit  
 Art No: GS05  
 Colour: white  
 RRP: 185,00 €



Product: E27 Cable  
 Art No: CB01  
 Colour: black  
 RRP: 45,00 €



Product: E27 Cable  
 Art No: CW01  
 Colour: white  
 RRP: 45,00 €



Product: Nap  
 Art No: N01  
 Colour: green  
 RRP: 380,00 €



Product: Nap  
 Art No: N02  
 Colour: brown  
 RRP: 380,00 €





Product: Fran XS  
 Art No: FR\_XS01  
 Colour: beige  
 RRP: 195,00 €



Product: Fran S  
 Art No: FR\_S01  
 Colour: beige  
 RRP: 280,00 €



Product: Fran M  
 Art No: FR\_M01  
 Colour: beige  
 RRP: 520,00 €



Product: Fran L  
 Art No: FR\_L01  
 Colour: beige  
 RRP: 540,00 €



Product: Fran XL  
 Art No: FR\_XL01  
 Colour: beige  
 RRP: 750,00 €



Product: Fran XS  
 Art No: FR\_XS02  
 Colour: green  
 RRP: 195,00 €



Product: Fran S  
 Art No: FR\_S02  
 Colour: green  
 RRP: 280,00 €



Product: Fran M  
 Art No: FR\_M02  
 Colour: green  
 RRP: 520,00 €



Product: Fran L  
 Art No: FR\_L02  
 Colour: green  
 RRP: 540,00 €



Product: Fran XL  
 Art No: FR\_XL02  
 Colour: green  
 RRP: 750,00 €



Product: Fran XS  
 Art No: FR\_XS03  
 Colour: coral  
 RRP: 195,00 €



Product: Fran S  
 Art No: FR\_S03  
 Colour: coral  
 RRP: 280,00 €



Product: Fran M  
 Art No: FR\_M03  
 Colour: coral  
 RRP: 520,00 €



Product: Fran L  
 Art No: FR\_L03  
 Colour: coral  
 RRP: 540,00 €



Product: Fran XL  
 Art No: FR\_XL03  
 Colour: coral  
 RRP: 750,00 €



Product: Fran XS  
 Art No: FR\_XS04  
 Colour: black  
 RRP: 195,00 €



Product: Fran S  
 Art No: FR\_S04  
 Colour: black  
 RRP: 280,00 €



Product: Fran M  
 Art No: FR\_M04  
 Colour: black  
 RRP: 520,00 €



Product: Fran L  
 Art No: FR\_L04  
 Colour: black  
 RRP: 540,00 €



Product: Fran XL  
 Art No: FR\_XL04  
 Colour: black  
 RRP: 750,00 €



Product: Matt Angora  
 Art No: MA01  
 Colour: azul  
 RRP: 310,00 €



Product: Matt Angora  
 Art No: MA02  
 Colour: inga  
 RRP: 310,00 €



Product: Matt Merino  
 Art No: MM03  
 Colour: mouse  
 RRP: 295,00 €



Product: Matt Merino  
 Art No: MM04  
 Colour: graphit  
 RRP: 295,00 €



Product: Matt Cotton  
 Art No: MC04  
 Colour: stop  
 RRP: 250,00 €



Product: Matt Cotton  
 Art No: MC05  
 Colour: day  
 RRP: 250,00 €



Product: Matt Cotton  
 Art No: MC06  
 Colour: rock  
 RRP: 250,00 €



Product: Matt Cotton  
 Art No: MC07  
 Colour: night  
 RRP: 250,00 €



Product: Ray Merino  
 Art No: RM02  
 Colour: coyote  
 RRP: 480,00 €



Product: Ray Merino  
 Art No: RM03  
 Colour: mouse  
 RRP: 480,00 €



Product: Ray Merino  
 Art No: RM04  
 Colour: graphit  
 RRP: 480,00 €



Product: Ray Angora  
 Art No: RA02  
 Colour: inga  
 RRP: 515,00 €



Product: Earl  
 Art No: EB01  
 Colour: nature  
 RRP: 380,00 €



Product: Earl  
 Art No: EB02  
 Colour: marbled  
 RRP: 640,00 €



# llot llov

llot llov ARTWORK SHOP GmbH | Kottbusser Damm 74 | 10967 Berlin | + 49 (0) 30 69 20 55 04 | [sales@llotllov.de](mailto:sales@llotllov.de) | [www.llotllov.com](http://www.llotllov.com)  
showroom: BAERCK store | Mulackstraße 12 | 10119 Berlin